

**OLYMPUS®**

**DIGITAL VOICE  
RECORDER**

**DS-330**

**ON LINE  
INSTRUCTIONS**

Thank you for purchasing an Olympus  
Digital Voice Recorder.

Please read these instructions for information about using  
the product correctly and safely.

Keep the instructions handy for future reference.

---

To ensure successful recordings, we recommend that  
you test the record function and volume before use.

**EN**

# For Safe and Correct Usage

Before using your new recorder, read this manual carefully to ensure that you know how to operate it safely and correctly. Keep this manual in an easily accessible location for future reference.

- The warning symbols indicate important safety related information. To protect yourself and others from personal injury or damage to property, it is essential that you always heed the warnings and information provided.

# General Precautions

- Do not leave the recorder in hot, humid locations such as inside a closed automobile under direct sunlight or on the beach in the summer.
- Do not store the recorder in places exposed to excessive moisture or dust.
- Do not use organic solvents such as alcohol and lacquer thinner to clean the unit.
- Do not place the recorder on top of or near electric appliances such as TVs or refrigerators.
- Avoid recording or playing back near cellular phones or other wireless equipment, as they may cause interference and noise. If you experience noise, move to another place, or move the recorder further away from such equipment.
- Avoid sand or dirt. These can cause irreparable damage.
- Avoid strong vibrations or shocks.
- Do not disassemble, repair or modify the unit yourself.
- Do not operate the unit while operating a vehicle (such as a bicycle, motorcycle, or go-cart).
- Keep the unit out of the reach of children.

.....  
IBM and PC/AT are the trademarks or registered trademarks of International Business Machines Corporation.

Microsoft and Windows are registered trademarks of Microsoft Corporation.

Intel and Pentium are registered trademarks of Intel Corporation.

Adobe and Acrobat Reader are registered trademarks of Adobe Systems Incorporated.

CORTOLOGIC is a registered trademark of Cortologic AG.

Apple, Macintosh, iMac, Mac, and PowerMac are trademarks or registered trademarks of Apple Computer, Inc.

Other product and brand names mentioned herein may be the trademarks or registered trademarks of their respective owners.

---

## Batteries

---

### Warning

- Batteries should never be exposed to flame, heated, short-circuited or disassembled.
- Do not attempt to recharge alkaline, lithium or any other non-rechargeable batteries.
- Never use any battery with a torn or cracked outer cover.
- Keep batteries out of the reach of children.
- If you notice anything unusual when using this product such as abnormal noise, heat, smoke, or a burning odor:
  - ① remove the batteries immediately while being careful not to burn yourself, and;
  - ② call your dealer or local Olympus representative for servicing.

---

## AC Adapter

---

### Warning

- Do not attempt to disassemble, repair or modify the AC adapter in any way.
- Keep foreign objects including water, metal, or flammable substances from getting inside the product.
- Do not moisten the AC adapter or touch it with a wet hand.
- Do not use the AC adapter in the vicinity of flammable gas (including gasoline, benzene and lacquer thinner).

### In case

- ... the internal parts of the AC adapter are exposed because it has been dropped or otherwise damaged:
- ... the AC adapter is dropped in water, or if water, metal flammable substances or other foreign objects get inside it:
- ... you notice anything unusual when using the AC adapter such as abnormal noise, heat, smoke, or a burning odor:
  - ① do not touch any of the exposed parts;
  - ② immediately disconnect the power supply plug from the power outlet, and;
  - ③ call your dealer or local Olympus representative for servicing. Continued use of the AC adapter under these circumstances could result in electric shock, fire or injury.

# Main Features

---

- The recorder stores highly compressed DSS format voice messages in 16 MB integrated flash memory.
- The recorder supports two recording modes, SP (Standard Playback) mode or LP (Long Playback) mode. (☞ P.18)
  - Continuous recording time is approximately 2 hours and 35 minutes in SP mode and approximately 5 hours and 30 minutes in LP mode.\*1
- The five folders can hold 199 files each, for a maximum of 995 recordings. (☞ P.12)
- You may assign your own names to folders. (☞ P.32)
  - Each of the 5 folders can have a name of up to 8 characters.
  - This recorder has 10 pre-set name templates.
- Recorded files may be moved from one folder to another. (☞ P.36)
- Has a built-in Variable Control Voice Actuator (VCVA) function. (☞ P.16)
- You can insert or delete index marks. (☞ P.27)
  - If you insert index marks during recording or playback, you will later be able to quickly find the recording you want to hear.
- The recorder has a Noise Cancel Function. (☞ P.23)
  - Cortologic AG Noise Suppression Technology reduces noise in files and enables clear sound playback.
- You can input file comments. (☞ P.35)
  - You can add comments of up to 100 characters to each recorded file.
  - This recorder has 10 pre-set comment templates.
- It has a large backlight full-dot display (LCD display screen).
  - The screen displays information about recorded voice files and easily understood operational messages.
- It has Fast Playback and Slow Playback functions to control playback speed. (☞ P.21)
- If you connect the recorder to a computer, you can use it as a USB microphone or USB speaker.\*2 (☞ P.69)
- Comes with DSS Player software. (☞ P.42)
  - If you transfer voice files recorded with the recorder to a PC, you can easily play back, organize, and edit the files.
- Connect the included USB cable to your computer for faster transmission speed.
  - It comes with a special cradle for convenient connection to a PC.

\*1: Available recording time for one continuous file. Available recording time may be shorter if many short recordings are made. (The displayed available recording time and recorded time are approximate indications.)

\*2: Do not use with Windows 98 as computer operation may become unstable.



# Table of Contents

---

## Getting Started

---

Identification of Parts .....	6	Hold .....	9
Inserting Batteries .....	8	Setting Time/Date .....	10
Using the AC Adapter .....	9		

## Basic operations

---

Recording .....	12	Playing .....	20
Using the Variable Control Voice Actuator (VCVA) .....	16	Continuous Playback .....	22
Recording Modes .....	18	Noise Cancel Function .....	23
Microphone Sensitivity .....	19	Erasing .....	24

## Other functions

---

Locking Files .....	26	Assigning File Comments .....	35
Index Marks .....	27	Moving Files Across Folders .....	36
Alarm Playback Function .....	28	System Sounds .....	38
LCD Contrast Adjustment .....	30	LCD Display Information .....	39
Backlight .....	31	Formatting the Recorder .....	40
Assigning Folder Names .....	32	Menu List .....	41

## Managing Files on Your PC

---

Using DSS Player Software .....	42	Direct Recording on PC and Editing on PC .....	59
Installing Software .....	44	Send Voice Files with E-mail .....	62
Uninstall Software .....	47	Changing User ID .....	62
Using Online Help .....	49	Change a Folder Name .....	63
Connecting to Your PC .....	50	Editing File Comments .....	63
Running DSS Player .....	52	Editing a Template .....	64
Window Names .....	54	Using Voice Recognition Software (optional) ....	65
Import Voice Files to Your PC .....	55	USB Microphone/USB Speaker .....	69
Play a Voice File .....	57		
Upload Voice Files to the Recorder .....	58		

## Other Information

---

Alarm Message List .....	70	Specifications .....	74
Troubleshooting .....	71	Technical Assistance and Support .....	75
Accessories (optional) .....	73		

# Identification of Parts

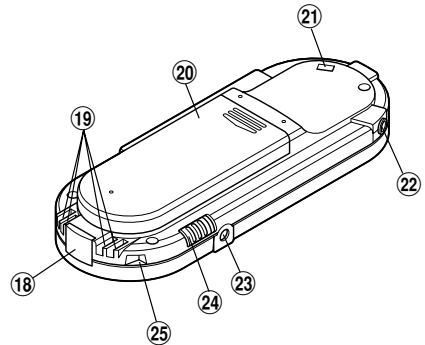
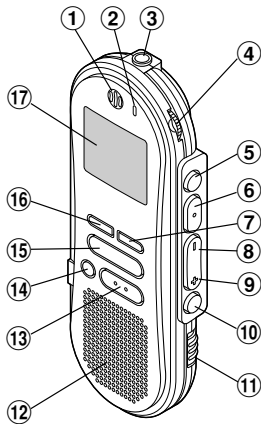

- ① Built-in microphone
- ② Record/Play indicator lamp
- ③ Microphone jack
- ④ VOLUME control
- ⑤ NEW button
- ⑥ REC (Record)/SET button
- ⑦ INDEX button
- ⑧ REW (Rewind) /- button
- ⑨ FF (Fast Forward) /+ button
- ⑩ FOLDER/MENU button
- ⑪ HOLD switch
- ⑫ Built-in speaker
- ⑬ STOP button
- ⑭ ERASE button
- ⑮ PLAY button

- ⑯ DISPLAY button
- ⑰ Display (LCD panel)
- ⑱ PC (USB) terminal
- ⑲ Cradle connection terminals
- ⑳ Battery cover
- ㉑ Strap hole
- ㉒ Earphone jack
- ㉓ Power jack
- ㉔ MICSSENS (Microphone sensitivity) switch
- ㉕ Cradle attachment point

## Display (LCD Panel)

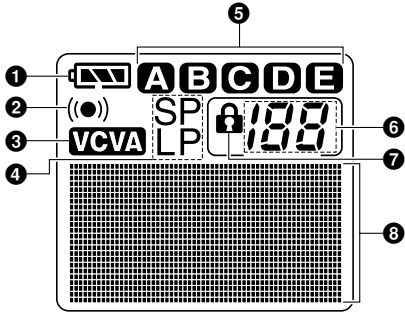

- ❶ Battery indicator
- ❷ Alarm indicator
- ❸ VCVA(Variable Control Voice Actuator) indicator
- ❹ Record mode indicator
- ❺ Folder
- ❻ Current file
- ❼ Erase lock indicator
- ❽ Character Information display

# Inserting Batteries

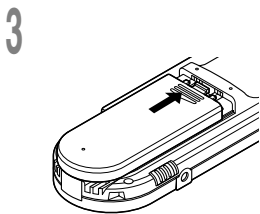
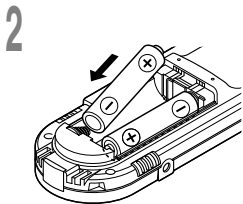
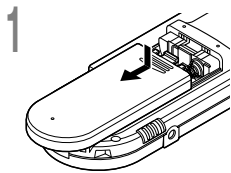

1 Lightly press down on the arrow and slide the battery cover open.

2 Insert two AAA alkaline batteries, observing the correct polarity.

3 Close the battery cover completely.

## Replacing batteries

The battery indicator on the display changes as the batteries lose power.

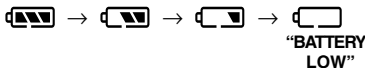

When  appears on the display, replace the batteries as soon as possible.

When the batteries are too weak, the recorder shuts down and “BATTERY LOW” appears on the display. AAA alkaline batteries are recommended.

## Notes

- **Be sure to stop the recorder before replacing the batteries.** Unloading the batteries while the recorder is recording, erasing or otherwise accessing an audio file may corrupt the file. If you are recording into a file and the batteries run out, you will lose your currently recorded file because the file header will not be able to close. So, it is crucial to change the batteries once you see only one mark in the battery icon
- Be sure to replace both batteries at the same time.
- **Never mix old and new batteries, or batteries of different types and/or brands.**
- If it takes longer than 1 minute to replace dead batteries, you may have to reset the time when you load fresh batteries. (P.10)
- Remove the batteries if you are not going to use the recorder for an extended period of time.



# Using the AC Adapter

Plug the optional AC adapter (Olympus Model A321 or A322) into household power outlet and connect the power plug to the recorder's power connector (DC 3 V) as shown in the illustration. Always stop recording before connection. Otherwise it may not be possible to play back the voice data being recorded.

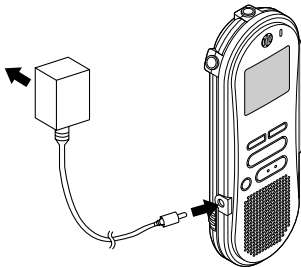

- **Always stop recording before connection or disconnection.**
- **When the AC adapter is not in use, disconnect the power supply plug from the power outlet.**
- **Use only the correct power supply voltage as indicated on the adapter.**
- **Do not use the AC adapter when connecting the recorder to the USB port.**

# Hold

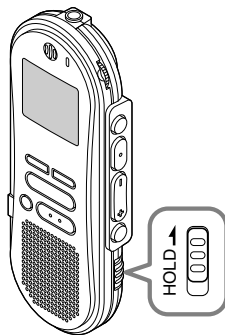

## Setting the HOLD switch to the HOLD position.

If you set the recorder to HOLD status by sliding the **HOLD** switch in the direction of the arrow, the current conditions will be preserved, and all buttons and switches except the **HOLD** switch will be disabled. This feature is useful when the recorder has to be carried in a bag or pocket.

**Remember to reset the HOLD switch when using the recorder.**

## Notes

- If you set the recorder to hold during Stop mode, the display goes dark. If you press any button, the time will flash for about 2 seconds, but the function of the button is disabled.
- The alarm will sound at the scheduled time even if the recorder is set to hold. The recorder begins to play the file associated with the alarm when you press any button.
- If you are recording when you switch the recorder to HOLD, recording will continue until the recorder memory runs out.

# Setting Time/Date

If you have set the time and date, information as to when an audio file is recorded is stored automatically with that file. The time and date should be set to ease file management tasks. The time and date setting is also needed to perform the alarm playback function. (REF P.28)

The hour indicator will flash automatically when you load batteries before using the recorder for the first time, or after the recorder hasn't been used for a long time. Proceed from step 3.

## Time/Date Screen

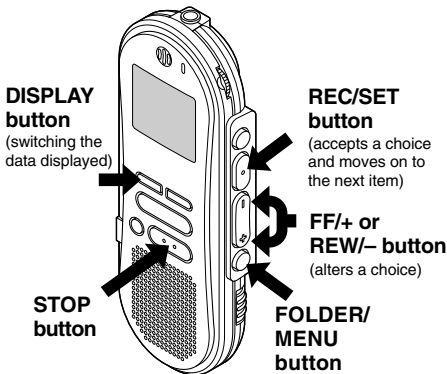
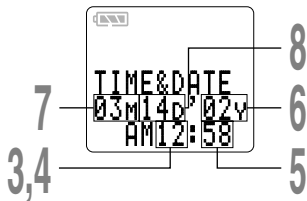

## Changing the Time/Date

- 1 Press and hold the **FOLDER/MENU** button for 1 second or longer.

The menu opens. (REF P.41)

- 2 Press the **FF/+** or **REW/-** button until "TIME&DATE" flashes on the display.



- 3 Press the **REC/SET** button. Time/Date screen appears. The hour indicator flashes, indicating the start of the Time/Date setup process.
  - You can choose between 12 and 24 hour display by pressing the **DISPLAY** button while setting the hour and minute.

Example: 5:45 P.M.

PM 5:45 ↔ 17:45

## 4 Set the hour.

- ① Press the **FF/+** button or **REW/-** button to set the hour.
- ② Press the **REC/SET** button to accept the hour.

## 5 Set the minute.

- ① Press the **FF/+** button or **REW/-** button to set the minute.
- ② Press the **REC/SET** button to accept the minute.

## 6 Set the year.

- ① Press the **FF/+** button or **REW/-** button to set the year.
  - ② Press the **REC/SET** button to accept the year.
- You can choose the order of the year, month, day by pressing the **DISPLAY** button while setting them.

Example: March 14, 2002

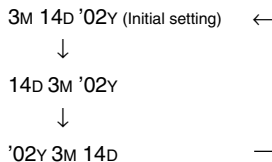

## 7 Set the month.

- ① Press the **FF/+** button or **REW/-** button to set the month.
- ② Press the **REC/SET** button to accept the month.

## 8 Set the date.

- ① Press the **FF/+** button or **REW/-** button to set the date.
- ② Press the **REC/SET** button to accept the date.

## 9 Press the **STOP** button to end.

- This completes the Time/Date setup procedure.

### Note

If you press the **STOP** button during the setup operation, the clock will use the items that were set to that point.

# Recording

The recorder provides five folders, **A**, **B**, **C**, **D** and **E**, and each message recorded in a folder is saved as a Digital Speech Standard (DSS) file. These five folders can be selectively used to distinguish the kind of recording; for example, **A** might be used to store private information, while **B** might be dedicated to holding business information (see P.32). Up to 199 messages can be recorded per folder. Four recording modes are available: new, append, overwrite, and insert.

## New Recording

Create a new file to record in.

Microphone

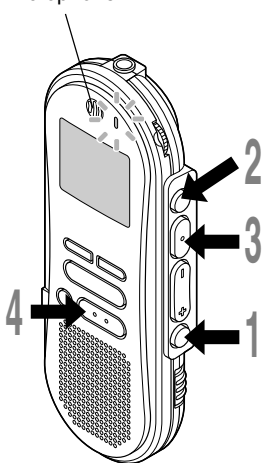

### 1 Press the **FOLDER/MENU** button to choose a folder.

The folder name is displayed for approximately 2 seconds.

- a) Folder name
- b) Total number of recorded files in the folder

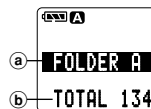

### 2 Press the **NEW** button to create a new file.

- c) New file number
- d) Current recording mode
- e) Remaining recording time

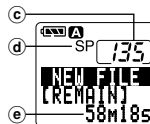

### 3 Press the **REC/SET** button to start recording.

The record/play indicator lamp glows red. Aim the microphone at the sound source.

- f) Current recording time
- g) Remaining recording time



### 4 Press the **STOP** button to stop recording.

If you want to append additional recordings to the same file, press the **REC/SET** button once again.

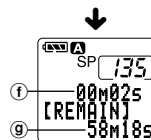

## Notes

- A beep will sound when remaining recording time reaches 60 seconds, 30 seconds, and 10 seconds while recording.
- “MEMORY FULL” or “FOLDER FULL” will be displayed when the memory or file capacity is full. Delete any unnecessary files before recording any further (P.24) or transfer voice files to your computer using DSS Player Software. (P.42)
- You cannot select a different mode than that of the original file before append recording. (P.18)

## Pause Recording

### Pause

Press the **REC/SET** button while recording.

- ➡ “REC PAUSE” will flash on the display.

### Resume Recording

Press the **REC/SET** button again.

- ➡ Recording will resume at the point of interruption.

## Note

The recorder stops when it has been left paused for 10 minutes or longer.

## To instantly review a recording (Quick review)

Press the **REW/-** button while recording, and release it when you want to start playing a file. The recorder plays up to the quick review point, then stops.

You can append additional recordings in the same file from that point.

## Listening While Audio Is Recorded (Recording Monitor)

Insert the earphone into the earphone jack to monitor what is being recorded. (Volume can be controlled using the Volume control.)

## To see the remaining recording time

The remaining recording time appears on the display when the recorder is stopped and the **STOP** button is pressed.



## Overwrite Recording

You can overwrite a previously recorded file from any point within the file. Note that the overwritten recordings will be erased.

**1 Choose and play the file you want to overwrite.**

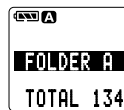

**2 Press the STOP button where you want to start overwriting.**

- a Current playback time
- b Total recording time of the file being played

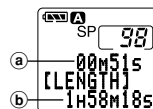

**3 Press the REC/SET button to start overwriting.**

The record/play indicator lamp glows red.

**4 Press the STOP button to stop overwriting.**

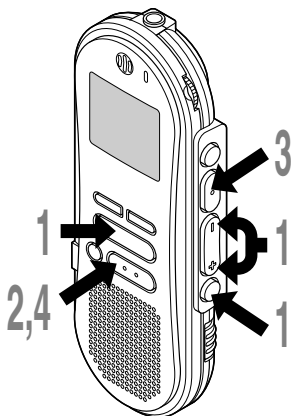

### Notes

- You can pause and resume overwrite recording by pressing the **REC/SET** button.
- You cannot select a different mode than that of the original file before overwrite recording. (☞ P.18)

## Insert Recording

Additional recordings can be inserted into previously recorded files.

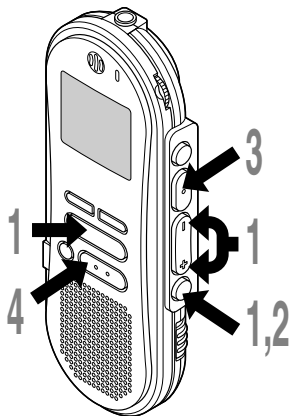

**1** Choose and play the file you want to insert.



**2** While playing a file, press the **FOLDER/MENU** button if you want to insert additional recording. "INSERT REC?" appears on the display.

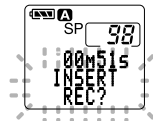

**3** Press the **REC/SET** button to start inserting additional recording.

As insert recording progresses, remaining memory grows smaller.

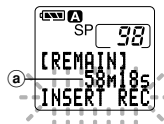

**a** Remaining recording time

**4** Press the **STOP** button to stop inserting additional recording.

### Notes

- You can pause and resume insert recording by pressing the **REC/SET** button.
- The recording time and date of the file into which recording has been inserted is updated to the time and date of when the inserted recording was recorded.
- You cannot select a different mode than that of the original file before insert recording. (P.18)

# Using the Variable Control Voice Actuator (VCVA)

When the microphone senses that sounds have reached a preset volume, the built-in Variable Control Voice Actuator (VCVA) starts recording automatically, and stops when the volume drops. Particularly helpful for extended recording, the VCVA not only conserves memory by turning off recording during silent periods, but also makes playback more efficient and convenient.

Using the Variable Control Voice Actuator (VCVA)

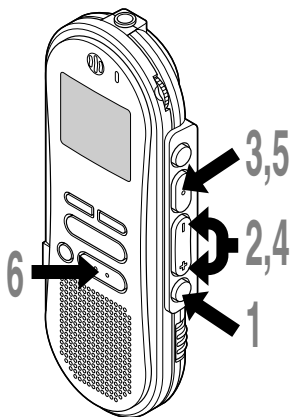

- 1 Press and hold the FOLDER/MENU button for 1 second or longer.**

The menu opens. (P.41)

- 2 Press the FF/+ or REW/- button until “VCVA” flashes on the display.**



- 3 Press the REC/SET button.**

The VCVA setup process begins.

- 4 Press the FF/+ or REW/- button to choose between ON and OFF.**

ON : Will start recording in VCVA mode.  
OFF : Will resume recording in normal mode.

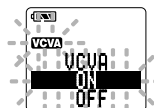

- 5 Press the REC/SET button to complete the setup screen.**

- 6 Press the STOP button to close the menu.**

When ON is selected, a **VCVA** indication will be displayed on the screen.



## 7 Start the recording.

When the sound volume is lower than the preset pause sound level, recording automatically pauses after approximately 1 second, and “STANDBY” flashes on the display. The record/play indicator lamp glows when recording starts and flashes when recording pauses.

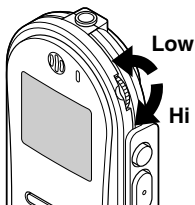
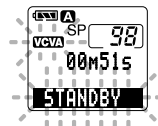

## Adjust the start/stop actuation level

Using the **VOLUME** control, adjust the start/stop actuation level.

The pause sound level can be set to any of 15 different values. The higher the value, the higher the sound sensitivity. At the highest setting, even a small sound will activate recording.

The VCVA pause sound level can be adjusted according to the ambient (background) noise.

### Notes

- The start/stop actuation level also varies depending on the selected microphone sensitivity mode. (☞ P.19)
- To ensure successful recordings, prior testing and adjustment of the start/stop actuation level is recommended.

# Recording Modes (REC MODE)

You can choose between two recording modes: SP (Standard Playback) mode and LP (Long Playback) mode. Once you choose a mode, files are recorded in the selected mode as long as you do not change the mode.

The included 16MB integrated flash memory holds approximately 2 hours and 35 minutes in SP mode and approximately 5 hours and 30 minutes in LP mode. Available recording time for one continuous file. Recording time may be shorter if many short recordings are made.

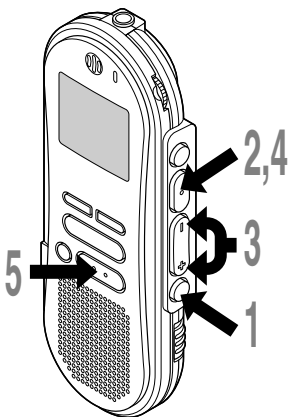

**1 Press and hold the **FOLDER/MENU** button for 1 second or longer.**  
"REC MODE" will be displayed on the screen.



**2 Press the **REC/SET** button.**  
The recording mode setup process begins.

**3 Press the **FF/+** or **REW/-** button to choose between SP and LP.**



**4 Press the **REC/SET** button to complete the setup screen.**

**5 Press the **STOP** button to close the menu.**

## Notes

- Choose SP mode for recording meetings or lectures with crisp clarity.
- You cannot select a different mode than that of the original file before append, overwrite, or insert recording. (P.14-15)
- Use SP mode in conjunction with voice recognition software. (P.65)

# Microphone Sensitivity

Microphone sensitivity is adjustable to meet recording needs.

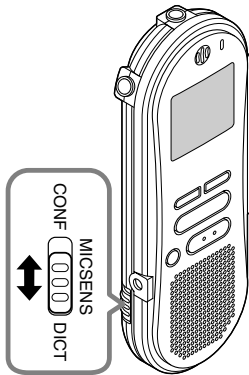

Using the **MICSSENS** switch, choose between the **CONF** and **DICT** positions.

**CONF** : High-sensitivity mode that records sounds in all directions.

**DICT** : Low-sensitivity mode suited for dictation.

## Notes

- If you want to clearly record dictation, switch to DICT mode and place the internal microphone close (5 to 10 cm) to the speaker.
- If the ambient (background) noise is too loud to get a clear recording even in DICT mode, we recommend that you use an ME-12 single directional microphone (sold separately).

# Playing

You can start playing a file at any point.

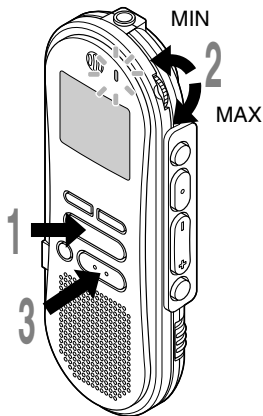

## 1 Press the **PLAY** button to start playback.

The record/play indicator lamp glows green.

- a Current playback time
- b Total recording time of the file being played

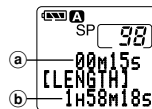

## 2 Adjust the **VOLUME** control to your liking.

## 3 Press the **STOP** button at any point you want to stop the playback.

Resume playback by pressing **PLAY** button again.

Playback functions	Operation	How to Cancel
<b>Fast Playback (F.PLAY)</b>	Press the <b>PLAY</b> button once while playing a file. → The recorder plays back at approximately 50% faster than normal rate.	Press the <b>PLAY</b> button 2 times while fast playing back. → Playback returns to normal rate.
<b>Slow Playback (S.PLAY)</b>	Press the <b>PLAY</b> button once while fast playing back. → The recorder plays back at approximately 25% slower than normal rate.	Press the <b>PLAY</b> button once while slow playing back. → Playback returns to normal rate.
<b>Fast Forward (FF)</b>	Press the <b>FF/+</b> button once while stopped. → (If the <b>FF/+</b> button is pressed at the end of a file, the recorder stops at the beginning of the next file. And if the <b>FF/+</b> button is pressed within 2 seconds, the recorder skips to the beginning of the next file.)	Press the <b>STOP</b> button. → The recorder stops immediately. (If you do not press the <b>STOP</b> button, the recorder will reach the end of the file and then stop automatically.)
<b>Rewind (REW)</b>	Press the <b>REW/-</b> button once while stopped. → (If the <b>REW/-</b> button is pressed at the beginning of a file, the recorder starts rewinding from the end of the previous file.)	Press the <b>STOP</b> button. → The recorder stops immediately. (If you do not press the <b>STOP</b> button, the recorder will reach the beginning of the file and then stop automatically.)
<b>Cue (CUE)</b>	Hold the <b>FF/+</b> button while stopped or playing a file.	Release the <b>FF/+</b> button. → The recorder will resume playback. (If you do not release the <b>FF/+</b> button, the recorder will reach the end of the file and then stop automatically.)
<b>Review (REV)</b>	Hold the <b>REW/-</b> button while stopped or playing a file.	Release the <b>REW/-</b> button. → The recorder will resume playback. (If you do not release the <b>REW/-</b> button, the recorder will reach the beginning of the file and then stop automatically.)

- If you press the **FF/+** button once while fast-forwarding or twice while stopped, the recorder will stop at the end of the file.(F.SKIP)
- If you press the **REW/-** button once while rewinding or twice while stopped, the recorder will stop at the beginning of the file (B.SKIP). If the **REW/-** button is pressed within 2 seconds, the recorder skips to the beginning of the previous file.

### Note

If you set Noise Cancel to “LOW” or “HI”, you cannot use the Fast Playback and Slow Playback functions.  
(<sup>63</sup> P.23)

# Continuous Playback (ALL PLAY)

When a file finishes playing back, the next file is played without stopping until it reaches the last file in the folder.

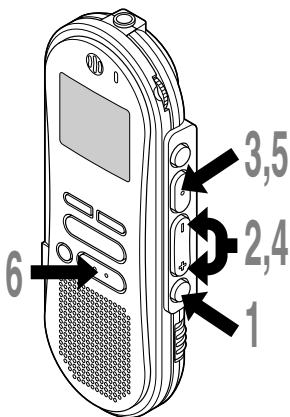

- 1 Press and hold the **FOLDER/MENU** button for 1 second or longer.

The menu opens. (P.41)

- 2 Press the **FF/+** or **REW/-** button until “ALL PLAY” flashes on the display.



- 3 Press the **REC/SET** button.

The Continuous Playback setup process begins.

- 4 Press the **FF/+** or **REW/-** button to choose between **ON** and **OFF**.

ON : Continuous playback.  
OFF : Returns to normal playback mode.



- 5 Press the **REC/SET** button to complete the setup screen.

- 6 Press the **STOP** button to close the menu.

# Noise Cancel Function

If recorded sound is difficult to hear because of noisy surroundings, adjust the Noise Cancel setting level. Noise will be reduced in the file when it's played back for clearer sound quality.

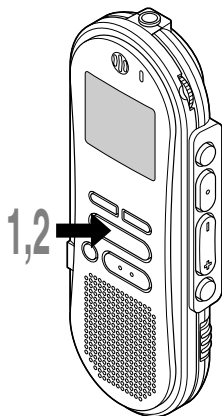

- 1 Press and hold the **PLAY** button for 1 second or longer while the file is playing.**

Displays currently set Noise Cancel level.

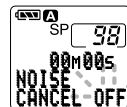

- 2 Press the **PLAY** button to choose a noise cancel level.**

Each time you press the **PLAY** button, the display changes as follows.

- OFF : (Initial Setting)  
↓
- LOW : Reduces noise.  
↓
- HI : Reduces more noise.

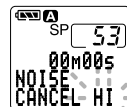

If the display is already set to Noise Cancel, start from step 2.

Change the Noise Cancel level within 8 seconds, otherwise the level is set at the display level and the display returns to its original view.

## Notes

- If you set Noise Cancel to "LOW" or "HI", the setting remains valid until it's set to "OFF".
- If you set it to "LOW" or "HI", the display flashes the Noise Cancel level for about 2 seconds when a file is played back.
- If you use the Fast Playback and Slow Playback function, you cannot set Noise Cancel to "LOW" or "HI".

(P.21)

# Erasing

## Erasing One File at a Time

A selected file can be erased from a folder.

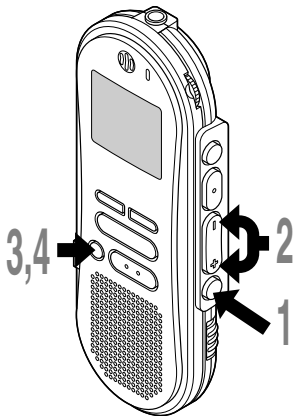

**1 Press the FOLDER/MENU button to choose a folder.**

The folder name is displayed for approximately 2 seconds.

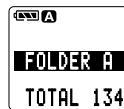

**2 Press the FF/+ or REW/- button to choose the file you want to erase.**

**3 Press the ERASE button.**

"FILE ERASE?" flashes on the display for approximately 8 seconds.

Ⓐ File to be erased

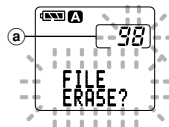

**4 Press the ERASE button once more when "FILE ERASE?" is flashing.**

The display changes to "FILE ERASE!" and erasing will start.



"ERASE DONE" is displayed when the file is erased. File numbers are incremented automatically.



### Notes

- If the **ERASE** button is not pressed within the 8 seconds after "FILE ERASE?" starts flashing, the recorder will revert to stop status.
- An erased file cannot be restored.
- Locked files cannot be erased. (P.26)



## Erase All Files from a Folder

All files in a folder can be erased simultaneously, except for locked files. (P.29)

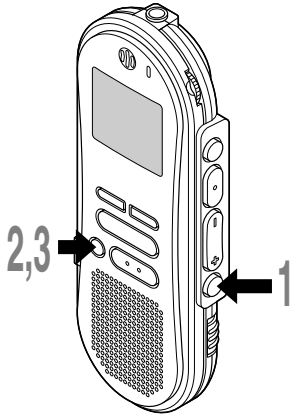

- 1 Press the FOLDER/MENU button to choose the folder you want to erase all files.**

The folder name is displayed for approximately 2 seconds.

- Folder from which to erase files

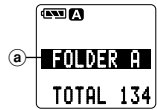

- 2 Press the ERASE button for 3 seconds or longer.**

“ALL ERASE?” flashes on the display for approximately 8 seconds.

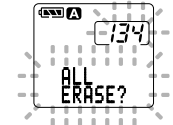

- 3 Press the ERASE button once more when “ALL ERASE?” is flashing.**

The display changes to “ALL ERASE!” and erasing will start.



“ERASE DONE” is displayed when the files are erased. Locked files are reassigned file numbers in ascending order.



### Notes

- If the **ERASE** button is not pressed within the 8 seconds after “ALL ERASE?” starts flashing, the recorder will revert to stop status.
- It might take more than 10 seconds to complete erasing all files.

# Locking Files (LOCK)

Locking a file keeps important data from being accidentally erased.

Locked files are not erased when you choose to erase all files from a folder. (☞ P.25)

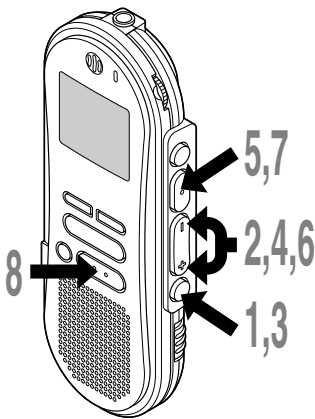

**1** Press the **FOLDER/MENU** button to choose a folder.

**2** Press the **FF/+** or **REW/-** button to choose the file you want to lock.

**3** Press and hold the **FOLDER/MENU** button for 1 second or longer.

The menu opens. (☞ P.41)

**4** Press the **FF/+** or **REW/-** button until “**LOCK**” flashes on the display.

**5** Press the **REC/SET** button.

The file locking setup process begins.

**6** Press the **FF/+** or **REW/-** button to choose between **ON** and **OFF**.

**ON** : Locks the file and prevents it from being erased.

**OFF** : Unlocks the file and allows it to be erased.

**a** File to be locked

**b** Erase lock indicator

**7** Press the **REC/SET** button to complete the setup screen.

**8** Press the **STOP** button to close the menu.

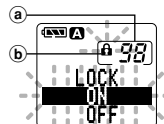

## Notes

- You cannot append, overwrite, or insert recordings into locked files. (☞ P.12-15)
- You cannot set index marks in locked files. (☞ P.27)

**26** • Any locked files are erased when you format the recorder. (☞ P.40)

# Index Marks

Index marks can be incorporated into a file during recording or playback to make it easy to locate interesting information.

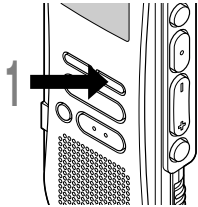

## Setting an Index Mark

- 1 Press the **INDEX** button during recording or playback to set an index mark.

An index number appears on the display.

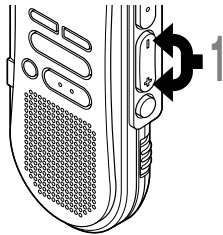
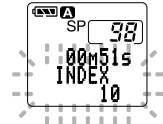

## Locating an Index Mark

- 1 Hold the **FF/+** or **REW/-** button while playing a file.

The recorder stops for 1 second when it reaches the index mark.

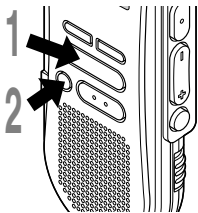

## Clearing an Index Mark

- 1 Locate the index mark you want to clear.
- 2 Press the **ERASE** button while the index number appears for approximately 2 seconds on the display.

The index mark is erased.

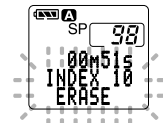

### Notes

- Up to 16 index marks can be set in a file. Attempting to set more index marks will cause "INDEX FULL" to appear on the display.
- Index marks cannot be set or cleared in a locked file. (P.26)

# Alarm Playback Function (ALARM)

The alarm playback function can be set to play a selected file at a pre-set time.

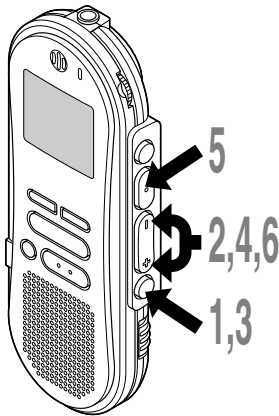

**1** Press the **FOLDER/MENU** button to choose a folder.

**2** Press the **FF/+** or **REW/-** button to choose the file to be played when the alarm sounds.

**3** Press and hold the **FOLDER/MENU** button for 1 second or longer.

The menu opens. (P.41)

**4** Press the **FF/+** or **REW/-** button until “ALARM” flashes on the display.

**5** Press the **REC/SET** button.

The alarm playback setup process begins.

**6** Press the **FF/+** or **REW/-** button to choose between **ON** and **OFF**.

ON : Enables alarm playback.

OFF : Disables alarm playback.

**a** File to be played when alarm sounds

**b** Alarm indicator

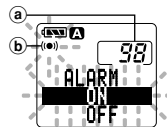

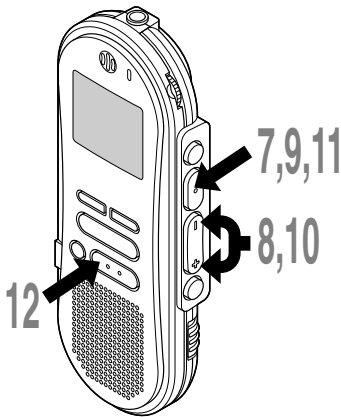

## 7 Press the **REC/SET** button to complete the setup screen.

When you choose ON, the hour indicator flashes.

When you choose OFF, the alarm indicator disappears and finishes with Step 12.



## 8 Press the **FF/+** or **REW/-** button to set the hour.

## 9 Press the **REC/SET** button to accept the hour.

The minute indicator flashes.

## 10 Press the **FF/+** or **REW/-** button to set the minute.

## 11 Press the **REC/SET** button to accept the minute.

## 12 Press the **STOP** button to close the menu.



An alarm tone will sound at the scheduled time. Press any button while the alarm sounds to play the file associated with the alarm.

### Notes

- The alarm playback function can be set for only one file at a time.
- The alarm will sound at the scheduled time every day unless the alarm playback setting is cleared.
- If you wish to change the file for alarm play, first turn the alarm settings "OFF", then make any desired new alarm settings.
- The alarm will sound for 5 minutes and then stop.
- If you are using the recorder at the scheduled time, the alarm will sound after you're done.
- The alarm will sound at the scheduled time even if the recorder is set to hold. The recorder begins to play the file associated with the alarm when you press any button.
- The alarm playback setting is cleared if the selected file is erased.

# LCD Contrast Adjustment (CONTRAST)

If the display is difficult to see because of environmental conditions and temperature, you can adjust the contrast using this function to easily see the LCD display (display contrast). Display contrast can be adjusted in 10 levels.

- 1 Press and hold the FOLDER/MENU button for 1 second or longer.**

The menu opens. (☞ P.41)

- 2 Press the FF/+ or REW/- button until “CONTRAST” flashes on the display.**



- 3 Press the REC/SET button.**

The LCD display contrast setup process begins.

- 4 Press the FF/+ or REW/- button to set the contrast level.**

You can adjust the LCD display contrast level from 1 to 10. (Initial setting .....6)



- 5 Press the REC/SET button to complete the setup screen.**

- 6 Press the STOP button to close the menu.**

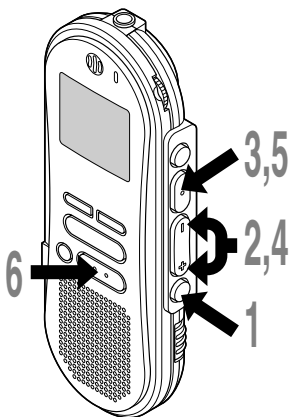

# Backlight (BACKLIGHT)

The backlight for the recorder will be activated for approximately 10 seconds each time a button is pressed. You can select whether or not you would like to use the backlight.

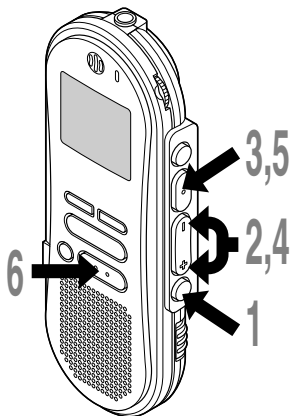

- 1 Press and hold the **FOLDER/MENU** button for 1 second or longer.

The menu opens. (P.41)

- 2 Press the **FF/+** or **REW/-** button until “**BACKLIGHT**” flashes on the display.



- 3 Press the **REC/SET** button.

The backlight setup process begins.

- 4 Press the **FF/+** or **REW/-** button to choose between **ON** and **OFF**.

**ON** : Backlight is enabled.  
**OFF** : Backlight is disabled.



- 5 Press the **REC/SET** button to complete the setup screen.

- 6 Press the **STOP** button to close the menu.

# Assigning Folder Names (FolderName)

You can give each of the five **A** to **E** folders a name with up to 8 characters. Frequently used words such as "dictation (**DICT.**)", "meeting (**MEETING**)" and "schedule (**SCHEDULE**)" are pre-set in a template.

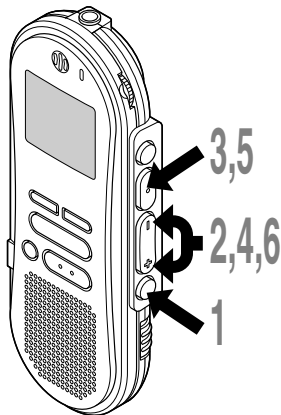

- 1 Press and hold the **FOLDER/MENU** button for 1 second or longer.**

The menu opens. (see P.41)

- 2 Press the **FF/+** or **REW/-** button until "FolderName" flashes on the display.**



- 3 Press the **REC/SET** button.**  
The folder name setup process begins.

- 4 Press the **FF/+** or **REW/-** button to choose the folder you want to name.**



- 5 Press the **REC/SET** button to accept the chosen folder.**



- 6 Press the **FF/+** or **REW/-** button to choose characters.**

The recorder assigns the following buttons to inputting procedures. (Available characters see P.34)



## Recorder buttons that are used to input characters

Button	Push	Action
<b>REC/SET</b>	Press once	To input the selected character and advance the input position.
	Press and hold	Confirms folder name or file comment.
<b>FF/+</b>	Press once	Selects character to be input: forward.
	Press and hold	Skips forward quickly through characters.
<b>REW/-</b>	Press once	Selects character to be input: back.
	Press and hold	Skips back quickly through characters.
<b>NEW</b>	-----	Returns to previous character.
<b>ERASE</b>	-----	To delete the flashing character.
<b>INDEX</b>	Press once	Switches between character groups (type).
	Press and hold	Quickly cycles through the character groups (types).
<b>DISPLAY</b>	Press once	Selects character to be input: skips ahead by 5 characters.
	Press and hold	Quickly skips ahead in increments of five characters.

### Use the two following methods to quickly find characters.

1. When the **INDEX** button is pressed, the displayed character group (example: Uppercase, lowercase, template, symbols) will change, and you can then press the **FF/+** or **REW/-** buttons to select characters.
2. Every time the **DISPLAY** button is pressed, it will skip ahead by five characters, so you can quickly move closer to the character you want.

(Currently displayed character) → (Space) → **DICT.** → **TO DO** → **A** → **F** → **K** → **P** → **U** → **Z** → **a** → **f** → **k** → **p** → **u** → **z** → **1** → **6** → , → ( → ) → \$ → ^ → (Space) → **DICT.** → **TO DO**...

If you press the **DISPLAY** button while a character other than one of the above appears, you will skip to the closest forward character in the above cycle.

Pressing the **DISPLAY** button again will then cycle through every fifth character as shown above.

example:

If you press the **DISPLAY** button while "**MEMO**" is displayed, "**TO DO**" will appear.

If you press the **DISPLAY** button while "**B**" is displayed, "**F**" will appear.

## Assigning Folder Names (FolderName)

### Available characters

Type of Characters		Action
Template	Folder name input	DICT. → MEETING → MEMO → NOTE → IDEA → TO DO → REMINDER → LECTURE → SCHEDULE → ARCHIVE
	File comment input	TOP PRIORITY → PRIORITY → IMPORTANT → CONFIDENTIAL → PRIVATE → DON'T FORGET → THINGS TO DO → MESSAGE → CONVERSATION → REPORT
Large caps		A → B → C → D → E → F → G → H → I → J → K → L → M → N → O → P → Q → R → S → T → U → V → W → X → Y → Z
Small caps		a → b → c → d → e → f → g → h → i → j → k → l → m → n → o → p → q → r → s → t → u → v → w → x → y → z
Numerics		1 → 2 → 3 → 4 → 5 → 6 → 7 → 8 → 9 → 0
Symbols		, → . → ; → ! → _ → ( → ) → [ → ] → { → } → + → - → = → # → \$ → % → & → ' → ` → ^ → @

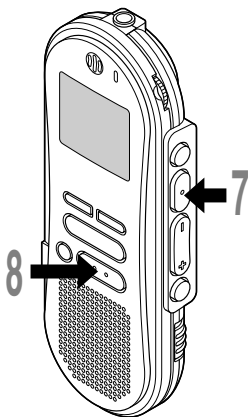

**7** When you have finished setting the folder name, press and hold the **REC/SET** button for **1 second or longer**.

This completes the folder naming procedure.

(If you wish to continue assigning names to folders, press the **REC/SET** button and repeat the procedure from step 4.)

**8** Press the **STOP** button to close the menu.

### Notes

- The folder naming process ends automatically when the eighth character is set.
  - If you input more than 8 characters, "OVERFLOW" appears on the display.
- 34** • You can use a PC to easily change the folder names on the recorder. (P.63)

# Assigning File Comments (COMMENT)

You can add comments of up to 100 characters to each recorded file.

If you include the date, time, and other information, you can easily find files without replaying them.

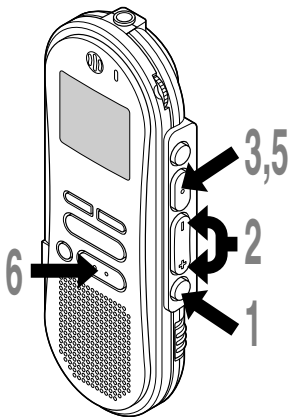

- 1 Press and hold the **FOLDER/MENU** button for 1 second or longer.**

The menu opens. (P.41)

- 2 Press the **FF/+** or **REW/-** button until “**COMMENT**” flashes on the display.**

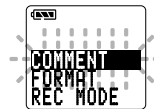

- 3 Press the **REC/SET** button.**

The file comment setup process begins.

- 4 Input the character.**

If you will input characters using the recorder, see step 6 of “Assigning Folder Names”. (P.32)

If you will input characters using a computer, see “Editing File Comments”. (P.63)



- 5 When you have finished setting the file comments, press and hold the **REC/SET** button for 1 second or longer.**

This completes the file comment input procedure.

- 6 Press the **STOP** button to close the menu.**

# Moving Files Across Folders

A recorded file can be transferred from one folder to another.  
The file is added at the end of existing files in the destination folder.

**1 Choose the file you want to move and play it.**

**2 Press the FOLDER/MENU button while playing the file.**  
“INSERT REC?” appears on the display.

**3 Press the FOLDER/MENU button again to change to “FILE MOVE?”.**

**4 Press the REC/SET button.**  
The destination folders blink on the display.

- a File to transfer
- b Current folder
- c Destination folder

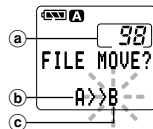
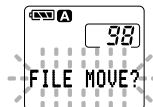
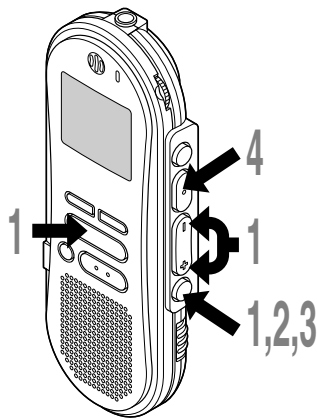

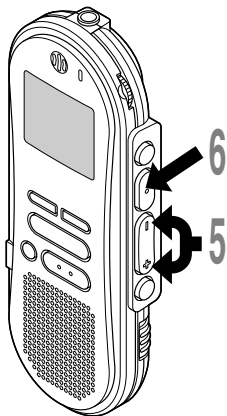

## 5 Press the **FF/+** or **REW/-** button to choose a destination folder.

If you choose the current folder as the destination folder, the selected file will move to the end of the existing files in it.

## 6 Press the **REC/SET** button to accept the chosen destination folder.

The file is moved.

Transfer is complete when “FILE MOVE DONE” appears.

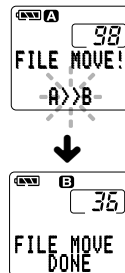

### Notes

- If the destination folder is full (a maximum of 199 files), “FOLDER FULL” appears on the display and files cannot be transferred to it.
- The file transfer process is aborted if you press the **STOP** button or leave the recorder idle for 8 seconds after you choose a destination folder.

# System Sounds (BEEP)

The recorder beeps to alert you to button operations or warn you of errors. System sounds may be turned off.

- 1 Press and hold the **FOLDER/MENU** button for 1 second or longer.

The menu opens. (P.41)

- 2 Press the **FF/+** or **REW/-** button until “BEEP” flashes on the display.



- 3 Press the **REC/SET** button. The system sound setup process begins.

- 4 Press the **FF/+** or **REW/-** button to choose between ON and OFF.

ON : System sounds are enabled.  
OFF : System sounds are disabled.



- 5 Press the **REC/SET** button to complete the setup screen.
- 6 Press the **STOP** button to close the menu.

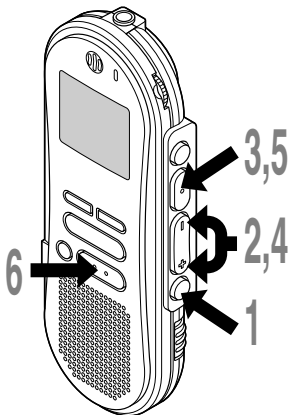

## Note

If the alarm playback function has been set, the alarm will sound at the scheduled time even if system sounds are turned off.

# LCD Display Information

This recorder is capable of switching views on its LCD display. If you press the **DISPLAY** button while stopped or while playing back a file, the LCD display will switch and you can confirm file information and various recorder settings.

## 1 Press the **DISPLAY** button.

The LCD display views will switch every time the **DISPLAY** button is pressed.

## While stop or playback mode

It will repeatedly cycle through ❶ to ❹.

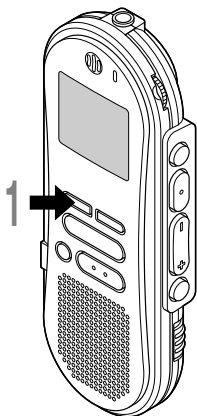

❶ **File length**  
SP [ 98 ]  
00m00s  
[LENGTH]  
1H38m18s

### ❶ File length

Shows how long a file is.

❷ **Time stamp**  
SP [ 98 ]  
00m00s  
[REC DATE]  
12H31D'02Y

### ❷ Time stamp

Shows the year, month, and date that the file was recorded.

❸ **Time stamp**  
SP [ 98 ]  
00m00s  
[REC TIME]  
AM12:58

### ❸ Time stamp

Shows the time that the file was recorded.

❹ **File comment\***  
SP [ 98 ]  
00m00s  
[COMMENT]  
-----

### ❹ File comment\*

Shows comment added to a file.  
(If there is no comment, "-----" will appear.)

\* If a comment contains many characters, it will scroll horizontally to display the complete comment.

# Formatting the Recorder (FORMAT)

If you format the recorder, all function settings will return to their defaults\*.

All files\*\* stored in the recorder will be deleted.

If you have important files that you want to save, connect the recorder to a computer and transfer those files from the recorder to the computer before formatting the device. (P.55)

\* Date and time settings won't be cleared, so you won't need to set them again.

\*\* Locked files will also be deleted.

- 1 Press and hold the **FOLDER/MENU** button for 1 second or longer.**

The menu opens. (P.41)

- 2 Press the **FF/+** or **REW/-** button until “**FORMAT**” flashes on the display.**

- 3 Press the **REC/SET** button.**

The formatting process is selected.

- 4 Press the **FF/+** or **REW/-** button to choose “**START**”.**

- 5 Press the **REC/SET** button again.**

Formatting begins and an indicator flashes on the display.

“**FORMAT DONE**” displays when formatting ends.

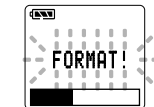
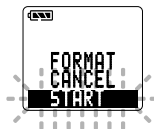
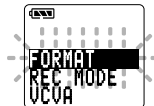
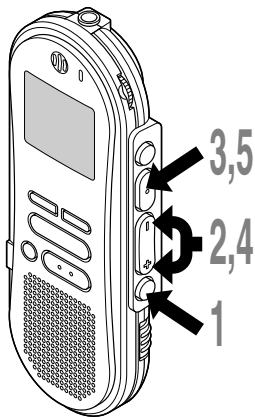

## Note

40 If no action is taken within 8 seconds after step 4, the menu will revert to the status of step 2.



# Menu List

Press and hold the **FOLDER/MENU** button for 1 second or longer.

① **REC MODE** Record mode setting (≡P.18). Selection between SP and LP modes.

② **VCVA** VCVA setting (≡P.16). Switch between ON (enabled) and OFF (disabled).

③ **LOCK** Locking files setting (≡P.26). Selection between ON (locked) and OFF (unlocked).

④ **ALARM** Alarm playback setting (≡P.28). Selection between ON (enabled) and OFF (disabled).

⑤ **ALL PLAY** Continuous playback setting (≡P.22). Selection between ON (enabled) and OFF (disabled).

⑥ **CONTRAST** LCD contrast adjustment (≡P.30). Adjust the level from 1 to 10.

⑦ **BACKLIGHT** Backlight setting (≡P.31). Selection between ON (enabled) and OFF (disabled).

⑧ **BEEP** System sounds setting (≡P.38). Selection between ON (enabled) and OFF (disabled).

⑨ **USB AUDIO** USB Microphone/Speaker setting (≡P.69). Selection between ON (enabled) and OFF (disabled).

⑩ **TIME&DATE** Date/time setting. In order of hour, minute, year, month and day. (≡P.10)

⑪ **FolderName** Folder naming. (≡P.32)

⑫ **COMMENT** Assigning file comments. (≡P.35)

⑬ **FORMAT** Recorder formatting. (≡P.40)

Press the **FF/+** button or **REW/-** button.

Press the **FOLDER/MENU** button during playback.

① **INSERT REC ?** Inserting recording. (≡ P.15)

② **FILE MOVE ?** Moving files. (≡ P.36)

Press the **FOLDER/MENU** button.

## Notes

- If you press the **STOP** button, the **REC/SET** button, or the **FOLDER/MENU** button during a menu setup operation, the recorder will stop and apply the items that were set to that point.
- The recorder will stop if you leave it idle for 3 minutes during a menu setup operation, when a selected item is not applied.

# Using DSS Player Software

---

By connecting the recorder to your PC, you will be able to use DSS Player in the following ways:

- Play and archive voice files from your PC.
- Send voice mail by sending an attached voice file with e-mail.\*
- Make backup files of the voice files on the recorder to your PC, and can later transfer files on your PC to the recorder, as necessary.

\* The e-mail software is not included in this package.

## Operating Environment

---

### Windows

<b>PC:</b>	IBM PC/AT compatible PC
<b>Operating System:</b>	Microsoft Windows 98/ 98SE/ Me/ 2000 Professional/ NT Workstation 4.0 with SP4 or later/ XP Professional, Home Edition
<b>CPU:</b>	Intel Pentium II class 333 MHz processor or better
<b>RAM:</b>	64 MB or more
<b>Hard drive space:</b>	10 MB or more
<b>Drive:</b>	2x or faster CD-ROM drive
<b>Sound card:</b>	Creative Labs Sound Blaster 16 or 100% compatible sound card
<b>Browser:</b>	Microsoft Internet Explorer 4.01 or later
<b>Display:</b>	800 x 600 pixels or more, 256 colors or more
<b>USB port:</b>	One free port
<b>Audio I/O terminals:</b>	Earphone output or speakers

---

### Notes

- USB ports are not available on PCs running Windows 95 or that have been upgraded from Windows 95 to any other OS.
- Certain functions, such as remote and direct recording, do not work on PCs that don't have USB ports.
- Do not use the recorder as a USB microphone/speaker on Windows 98 as computer operation may become unstable. (Use only with Windows 98SE or later versions of the OS.)

---

## Macintosh

- PC:** iMac/ iBook/ Power Mac G3,G4/ PowerBook G3  
(The computer must support a standard USB port.)
- Operating System:** Mac OS 8.6/9.0/9.1/9.2/10.1
- RAM:** 16 MB or more
- Hard drive space:** 5 MB or more
- Drive:** 2x or faster CD-ROM drive
- Display:** 800 x 600 pixels or more, 256 colors or more
- USB port:** One free port
- Audio I/O terminals:** Microphone input and earphone (or speaker) output

# Installing Software

Before you connect the USB cable to the recorder and your PC, you must first install the software.

**Be sure to confirm the following before installation:**

- Exit all running applications.
- Eject the floppy disk if you are using one.
- If you are running Windows 2000 /XP (Professional only) on a network, you need to log on as an administrator.

## Windows

### 1 Insert Olympus DSS Player into the CD-ROM drive.

The installation program will start automatically. Once the program starts, jump to step 4. If it does not, follow the procedures in steps 2 and 3.

### 2 Click on the [Start] button and select [Run].

### 3 Enter “D:/Setup.exe” in the [Open] field and click on [OK].

This is assuming the CD-ROM is in drive D.

### 4 The installation Language Selection dialog box opens.

Click on the desired language to select it.

### 5 Click on [Next] when the DSS Player opening screen appears.

### 6 Confirm your acceptance of the terms of the Licensing Agreement.

You must accept the terms of the Licensing Agreement to install DSS Player. If you accept them, click on [Yes].

### 7 Register user information.

Register user information. Enter your name, company name, and license ID number (serial number).

The license ID number is printed on the license ID card. Click on [Next]. A confirmation dialog box opens, click on [Yes].

### 8 Select where to install DSS Player.

This lets you specify the folder in which to install DSS Player. Click on [Browse] to find the desired installation folder. To accept the default folder, click on [Next].

#### Note

If the installation folder does not exist, a confirmation dialog box opens to get your permission to create a folder for this purpose. Click on [Yes].

- 9 Select a program menu folder.**

You may change the program menu folder to another one, such as [Start Up]. To accept the default folder, click on [Next].
- 10 Authorizing the start of file copying.**

Confirm all “Current Settings”. To accept them, click on [Next].

**Note**  
To change the program menu folder or installation folder, click on [Back].
- 11 Copy files.**

Wait until DSS Player is installed on your PC, then click on [Finish].
- 12 Set up Acrobat Reader.**

When the Acrobat Reader Setup dialog box opens, click on [Next].
- 13 Select where to install Acrobat Reader.**

Specify the folder in which to install Acrobat Reader. To accept the default folder, click on [Next].
- 14 Setup Status.**

Wait until Acrobat Reader is installed on your PC.
- 15 Exit Acrobat Reader setup.**

When the Exit Setup dialog box opens, click on [OK].
- 16 Install Shield Wizard complete.**

You may be requested to restart your PC when setup is complete. If so, make sure that [Yes, I want to restart my PC now.] is selected before clicking on [Finish]. Then, when the message to do so appears, shut your PC off and restart it.

### Macintosh

**1 Insert DSS Player for Mac into the CD-ROM drive.**

**2 Double-click on CD icon.**

Double-click on the desired language to select it.

**3 Double-click on DSS Player for Mac Installer icon.**

The installation program will start.

**4 Click on [Continue] when the DSS Player for Mac opening screen appears.**

**5 Confirm your acceptance of the terms of the Licensing Agreement.**

You must accept the terms of the Licensing Agreement to install DSS Player for Mac. If you accept them, click on [Agree].

**6 Select where to install DSS Player for Mac.**

This lets you specify the folder in which to install DSS Player for Mac. To accept the default folder, click on [Choose]. If you use OS10.1, proceed to step 7.

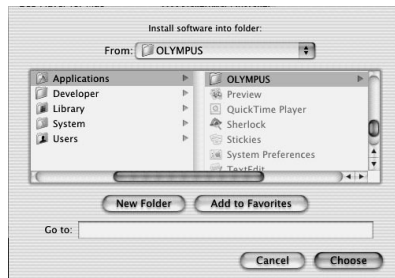

**7 Restart the computer.**

You need to restart your computer when DSS Player for Mac is installed. To continue, click on [Yes]. To cancel installation, click on [No].

**8 Completing setup.**

Installation has finished. Click either [Quit] or [Restart]. To continue with the installation, click the Continue Set up Acrobat Reader. When the Acrobat Reader Setup dialog box opens, click on [Next].

# Uninstall Software

The process of removing software installed on your PC is called uninstalling. Perform uninstalling when you no longer need the software.

## Windows

- 1 Exit DSS Player.
- 2 Click on the [Start] button, select [Programs], then [Olympus DSS Player 2002].  
(in Windows XP, click on the [Start] button, select [All Programs], then [Olympus DSS Player 2002].)
- 3 Click on [Uninstall Olympus DSS Player 2002].
- 4 Follow the directions on screen to start the uninstall process.

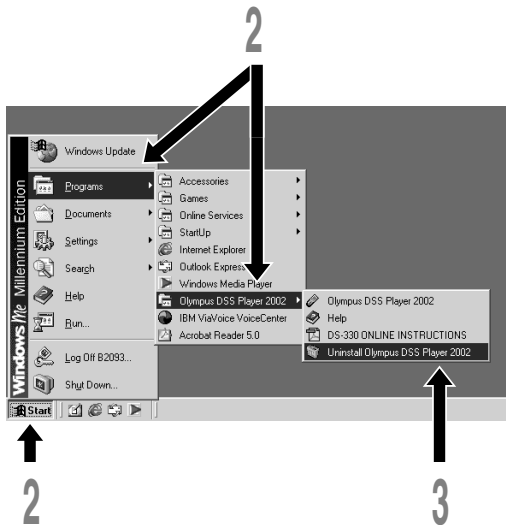

### Macintosh

**1** Exit DSS Player.

**2** Double-click the Macintosh HD icon.

If you use OS10.1, proceed to step 5.

**3** Delete the following eight drivers from Function Enhancement in the System Folder:

(OS 8,9 only)

“DSS10USBDriver”

“DSS10USBShim”

“DSS1USBDriver”

“DSS1USBShim”

“DSSFSUSBDriver”

“DSSFSUSBShim”

“DSSUSBDriver”

“DSSUSBShim”

**4** Delete the following folder from the System Folder:

(OS 8,9 only)

“DSS Player for Mac Help”

**5** Delete the following file from Initialization in the System Folder:

“DSS Preference”

(In OS10.1, User folder: Library folder: Preference folder.)

**6** Delete the DSS Player for Mac folder.

If you optionally created a new message folder, be sure to delete that message folder as well.



# Using Online Help

To open Online Help, do either of the following:



(Windows)

- Click on the [Start] button, select [Programs], then [Olympus DSS Player 2002], then click on [Help].
- While DSS Player is running, choose [Contents] from the [Help] menu.
- While DSS Player is running, press [F1] on the keyboard.

(Macintosh)

- While DSS Player is running, choose [DSS Player for Mac Help] from the [Help] menu.

## Search by contents

- 1 Once the Online Help screen appears, click on the Contents tab.**
- 2 Double-click on the  icon of the desired topic heading.**  
The title of the topic is displayed.
- 3 Double-click on the  icon of the desired topic.**  
An explanation of the topic is displayed.



## Search by keyword

- 1 Once the Online Help screen appears, click on the Index tab.**  
A list of keywords by which you can search is displayed.
- 2 Enter text.**  
Matching keywords are located automatically.
- 3 Choose a topic, then click on [Display].**  
An explanation of the topic is displayed.

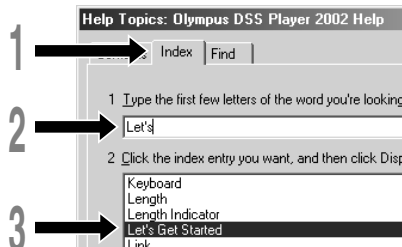

## Note

For more information on menus and operations, refer to Online Help. You will be able to use Online Help after DSS Player is installed.

# Connecting to Your PC

Be sure to finish installing DSS Player before connecting the recorder. If you connect the recorder before installing DSS Player, the “Add New Hardware Wizard” dialog box will open. If this happens, click on [Cancel] to exit the wizard, then install DSS Player.

Once you connect the recorder to your PC, the included USB cable will supply the power so you will not have to use batteries or an AC adapter with the recorder.

You can directly connect the recorder's USB terminal to your PC, or use the cradle included in the package (desktop holder).

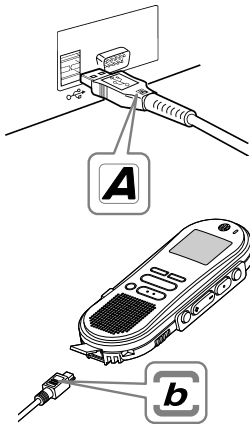

## Connecting to your PC using the USB connection cable

**1** Insert end A of the USB cable to your PC's USB port or USB hub.

**2** Confirm that the recorder is not in use before attaching end b of the USB cable to the PC terminal port of the recorder.

“REMOTE” is displayed on recorder if the USB cable is connected.



### Notes

- NEVER disconnect the USB connecting cable while the record/play indicator lamp is flashing. If you do, the data will be destroyed.
- Some PCs and USB hubs may not supply sufficient power and the recorder may not connect. If that happens, turn the USB AUDIO "OFF" in the recorder's menu settings. (☞ P.41)
- Refer to the user's manual for your PC regarding the USB port or USB hub on your PC.
- Be sure that you connect the USB cable either directly to the USB port on your PC or the self-power (AC adapter connection) USB hub.
- Be sure to push the cable connector all the way in. Otherwise, the recorder may not operate properly.
- Release the **HOLD** switch. (☞ P.9)

## Connecting to your PC using the cradle

### Place the recorder on the cradle

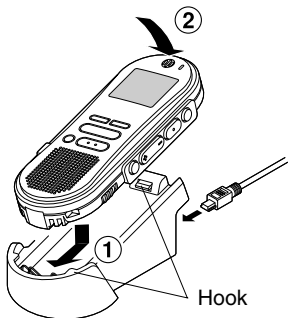

- 1** Insert end A of the USB cable to your PC's USB port or USB hub.
- 2** Connect the end b of the USB connection cable to the cradle.
- 3** Make sure that the recorder is stopped, and place it in the cradle.

When you place the recorder on the cradle, ①insert the recorder so its bottom slot meets the hook on the front of the cradle (at the low end). ②Hold the top of the recorder and push it against the cradle until it clicks. "REMOTE" is displayed on recorder if the USB cable is connected.

### Remove the recorder from the cradle

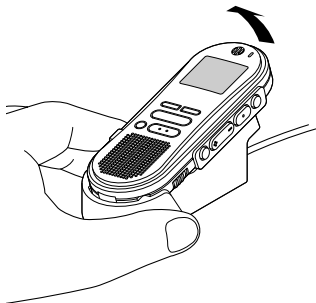

- 4** Make sure that the recorder's record/play indicator lamp isn't flashing, and remove the recorder from the cradle.
- Hold the cradle with your hand, and raise the recorder from the top end to remove it from the hook, as shown in the illustration.
- 5** Disconnect the USB connecting cable.

### Notes

- Do not needlessly touch the connection point on the front of the cradle (at the low end), as that may cause damage resulting in a bad connection.
- Release the **HOLD** switch. (☞ P.9)

# Running DSS Player

## Windows

**1 Start Windows.**

**2 Connect the recorder to your PC.**

For the connection procedure, refer to “Connecting to Your PC”. (P.5)

When you connect the recorder to your PC for the first time, the USB Driver Setup Wizard will open. Follow the instructions on the screen to install the driver.

**3 Click on the [Start] button, select [Programs], then [Olympus DSS Player 2002].**

(in Windows XP, click on the [Start] button, select [All Programs], then [Olympus DSS Player 2002].)

**4 Click on [Olympus DSS Player 2002].**

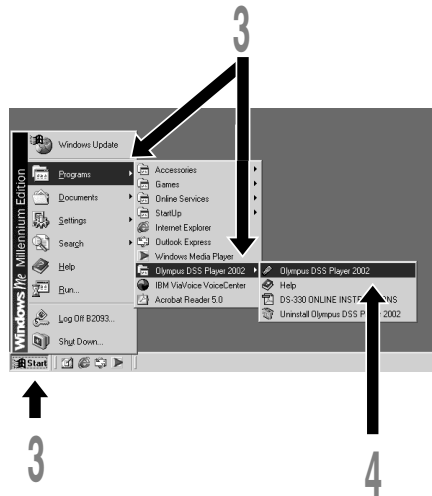

## About automatic startup

By connecting the recorder to your PC, you can automatically start an application.

**1 Right-click on  icon of the Task Bar on the lower right-hand corner on the screen, then click on Select startup application.**

**2 Check the application to automatically start.**

The application that you check will automatically start. If you do not want it to automatically start, uncheck the application.

## Notes

- You will not be able to run the included DSS Player 2002 and DSS Player 3.0/3.1/3.5 for DS-150/320 at the same time.
- If you connect the recorder before installing DSS Player, the “Add New Hardware Wizard” dialog box will open. If this happens, click on [Cancel] to exit the wizard, then install DSS Player.

## Macintosh

To start DSS Player for Mac, follow these steps:

It is assumed that DSS Player for Mac has been installed. For installation instructions, see Installing DSS Player for Mac. (P.46)

### 1 Start your Macintosh.

### 2 Connect the recorder to your PC.

For cable connection instructions, see “Connecting to Your PC”. (P.50)

### 3 Double-click the DSS Player for Mac folder.

The DSS Player for Mac folder opens.

### 4 Double-click DSS Player.

DSS Player for Mac launches.

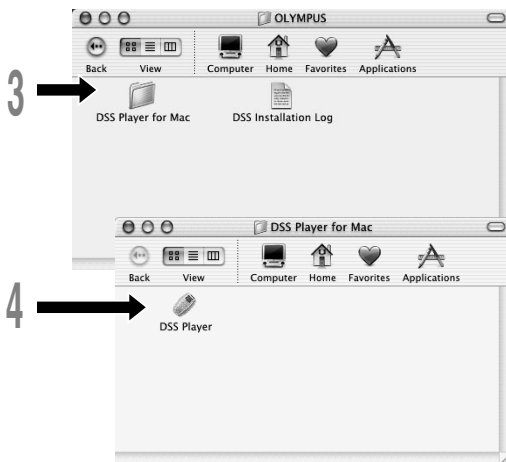

# Window Names

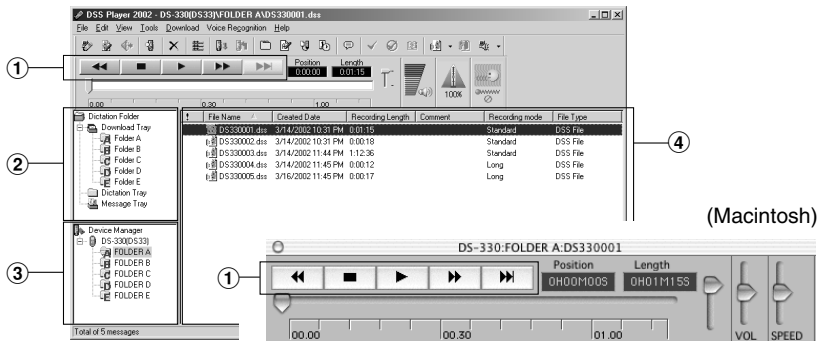

(Windows)

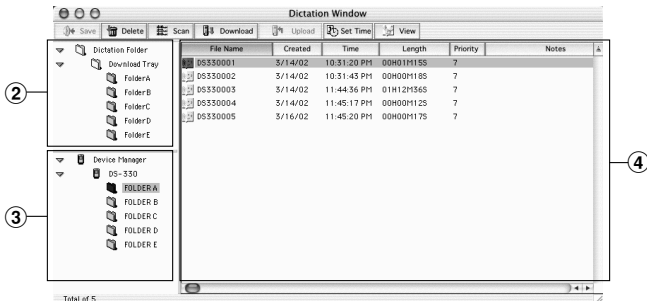

## ① Play Control Bar

Control buttons to play and stop voice files.

## ② Dictation Folder Window

Will display the directory structure of the DSS, WMA, WAVE (Windows only) and AIFF (Macintosh only)-format files stored on your PC's hard disk.

## ③ Device Manager Window

Will display the directory structure of the folders in the recorder.

## ④ Voice File List Box

Will display the folders selected in ② and ③.

# Import Voice Files to Your PC

Importing voice files to your PC from the recorder is called downloading. With DSS Player, there are three ways to download voice files to your PC:

- Download Selected Files  
Download one or several voice files to your PC.
- Download Folders  
Download all the voice files in one folder.
- Download All  
Click on the  icon and download all the voice files stored in the recorder to your PC.

The following is an explanation of “Download Selected Files”. For explanations of “Download Folders” and “Download All”, refer to Online Help.

## Download Selected Files

### 1 Select the folder.

From the Device Manager window, select the folder that contains the voice file you would like to download. The illustration shows that Folder A has been selected.

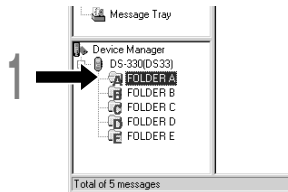

### 2 Select the voice file.

Select the voice file you would like to download from the Voice File List Box. To select more than one file, hold either the [Ctrl] or [Shift] key and select files. The illustration shows that one voice file is selected.

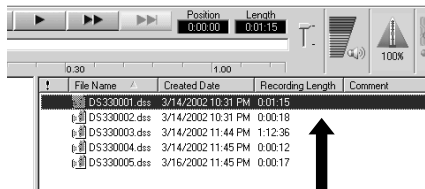

### 3 Download the voice file.

(Windows)

From the [Download] menu, click on [Download Selected Files].

(Macintosh)

From the [Tools] menu, click on [Download Selected Files].

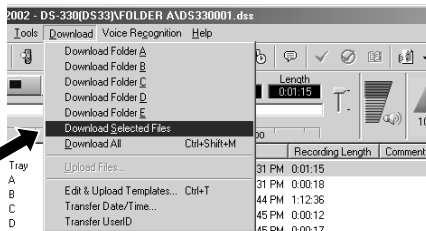

### 4 Download complete.

Once the transmission screen closes and the record/play indicator lamp on the recorder goes dark, the downloading is completed.

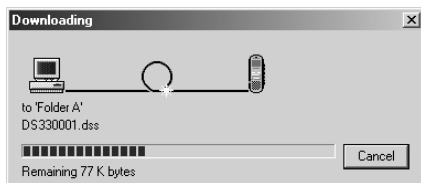

### Notes

- NEVER disconnect the USB connecting cable while the record/play indicator lamp is flashing. If you do, the data will be destroyed.
- Depending on the size of the voice file and your PC, it may take some time to download the files.
- The downloaded files will be stored in the download tray folder that corresponds to the folder in the recorder. (Example: A voice file downloaded from Folder A will be stored in download tray A on your PC.)
- If a voice file already exists on your PC with the same name, date and time recorded, the new file will not be downloaded.



# Play a Voice File

## 1 Select the folder.

Select the folder that contains the voice file you would like to play.

The illustration shows that to select from among voice files already downloaded, Folder A in the Dictation Folder window was selected.

## 2 Select the voice file.

Select the voice file to play from the Voice File List Box.

## 3 Play the voice file.

Click on the  (play) button of the Play Control Bar.

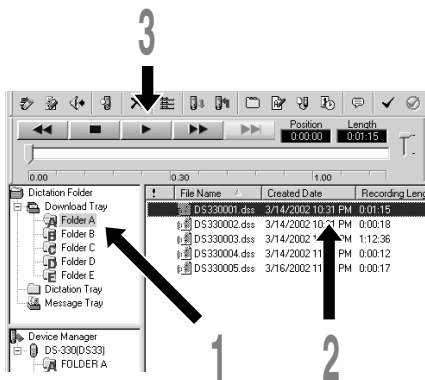

Other play controls such as Rewind, Fast Forward, Stop, Speed Control, Volume Control, Time Axis, and Index Skip can also be operated. For details, refer to Online Help.

If you connect the recorder and use DSS Player to play back a file, you can use the recorder as your PC speaker. For connection procedures, see "USB Microphone/USB Speaker". (☞ P.69)

## File name

File names are assigned in the following manner:

**DS330001.dss**

**Extension**

**File number** ..... A serial number automatically assigned by a Digital Voice Recorder.

**User ID** ..... The name that has been set on the Digital Voice Recorder. The default name on the Digital Voice Recorder is **DS33**. The user ID can be modified with DSS Player. (☞ P.62)

## Note

DSS Player cannot play back WMA files with DRM (Digital Rights Management) copyright protection that constrains distribution and playback.

# Upload Voice Files to the Recorder

DSS Player has a feature to enable you to upload DSS-format voice files from your PC to the recorder.

## 1 Select the folder.

Select the folder that contains the voice file to upload from the Dictation Folder window.

## 2 Select the voice file.

Select the voice file to upload from the Voice File List Box.

## 3 Select the folder to upload.

(Windows)

From the [Download] menu select [Upload Files] or click on the Upload icon. Once the folder list box where the file is to be uploaded is displayed, select the folder from which the file is to be uploaded.

(Macintosh)

From the [Tools] menu, click on [Upload Files].

## 4 Upload the voice file.

The voice file is uploaded to the recorder.

## 5 Upload complete.

Once the transmission screen closes and the record/play indicator lamp on the recorder goes dark, the uploading is completed.

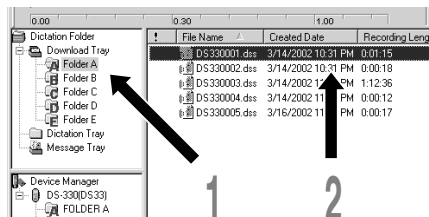

You can also drag and drop files from the Voice File List Box to the Device Manager window.

## Notes

- NEVER disconnect the USB connecting cable while the record/play indicator lamp is flashing. If you do, the data will be destroyed.
- You will not be able to upload a file if another file with the same name already exists at the destination.
- You can upload only DSS files to the recorder.

# Direct Recording on PC and Editing on PC

## Windows

If you want to record and edit voice files using your PC, open the [Remote Edit] window while the recorder is connected to your PC (see P.50). You can easily create new files, insert recordings, overwrite recordings, edit index marks, and do other tasks. See the Online Help for details.

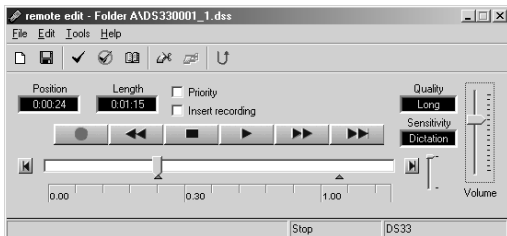

### Recording a new file

**1** From the Main Window, select [New File] in the [File] menu, or click  icon.

Remote Edit screen opens.

**2** Press the  (record) button to start recording.

**3** Press the  (stop) button to stop recording.

### Editing existing files

**1** From the Main Window, select the file you want to edit from the Voice File List Box.

**2** Select [Edit File] in the [File] menu, or click  icon.

Remote Edit screen opens.

**3** Edit it.  
You can partially delete recordings, edit index marks and priorities, insert recordings from the position designated using the position control bar (check on [Insert recording]) and overwrite recordings.

### Notes

- You cannot edit WAV files.
- You can only edit files in DSS format.

### Macintosh

You can record voice files from a Digital Voice Recorder directly to a computer. With a Digital Voice Recorder connected, choose the [Direct Record to PC] command from the [Tools] menu.

#### Recording a new file

##### 1 Set recording.

A recording setup window opens.  
Click on [Set File Name].

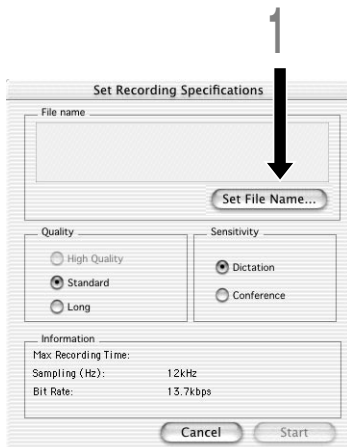

##### 2 Set the recording destination and file name.

Type the recording destination folder name and file name and click on [Save].



### 3 Start recording.

Click on [Start] in the recording setup window.

Recording will start.

You can only change the sound quality and sensitivity settings before recording.



### 4 Stop recording.

Click on [Stop] in the Record Window.



## Converting File Formats to AIFF Files\*

Choose the [Save as] from the [File] menu.

When a DSS file is converted to an AIFF file, unique DSS information such as priority and index marking will be lost.

\* AIFF format ..... The standard Macintosh audio file format with the aif extension. It cannot contain index and priority settings.

### Notes

- AIFF files cannot be converted to DSS format.
- You cannot partially delete, add index marks to, or set priorities.

# Send Voice Files with E-mail

You can attach voice files to your e-mails.

How to send attachment with e-mails, refer to the user's manual for your e-mail software.

- Even if the person to whom you send a voice file does not have DSS Player, he/she will be able to play the voice file using DSS Player-Lite. You can download DSS Player-Lite free from the Olympus home page, <http://www.olympus.com/>

- 1 Start DSS Player.**
- 2 Start the e-mail software, then select New Mail.**
- 3 Attach the voice file.**  
Select the voice file to attach from the Voice File List Box of DSS Player and drag and drop the file into the New Mail text window.

## Note

If your e-mail software is not compatible with the above operation, select the voice file to send from the folder where the voice file is located and send the file as an attached file according to the functions of the e-mail software. (Windows) The default folder is set to C:\Program Files\Olympus\DSS Player 2002\Message\Folder A (or B, C, D, E). (Macintosh) By default, voice files are stored on Macintosh HD: DSS Player for Mac: Message Folder: FolderA (or B, C, D, E).

# Changing User ID

The user ID is used in DSS file names (P.57) that are recorded on a Digital Voice Recorder.

- 1 Enter the user ID in the [Transfer UserID] window.**  
(Windows) From the [Download] menu.  
(Macintosh) From the [Tools] menu.
- 2 Click on [Transfer].**  
The new user ID will be transferred to the Digital Voice Recorder.



# Changing a Folder Name

---

## Changing a folder name in the Voice Folder window

(Windows)

You can change a folder name using the [Rename Folder] command from the [Edit] menu. A folder name can be up to 20 characters long and cannot use \/:\*?"<>|.

(Macintosh)

Choose the [Rename Folder] command from the [File] menu.

## Changing a folder name in the Device window

(Windows)

Right-click the folder name to change, select the [Rename Folder] and input the new folder name.

(Macintosh)

Choose the [Rename Folder] from the [Tools] menu and type a folder name.

The names of the folders on the Digital Voice Recorder is updated with the new folder names.

Device Window folder names consist of a string of eight or fewer single-byte alphanumeric characters.

# Editing File Comments

---

You can use a PC to create or edit file comments in DSS Player in the [Edit Comments] window, and transfer them from the PC to the recorder. You can also edit file comments imported from the recorder to a PC.

Choose the [Edit Comments] command from the [Tools] menu.

Files comments can use up to 100 alphanumeric characters and symbols.

# Editing a Template

You can edit folder name and file comment templates in DSS Player in the [Edit & Upload Templates] window and transfer them to the recorder. Templates downloaded from the recorder can also be edited.

(Windows)

Select [Edit & Upload Templates] from [Download] to open the [Edit and Upload Template] window.

(Macintosh)

Select [Edit & Upload Templates] from [Tools] to open the [Edit and Upload Template] window.

Up to 20 alphanumerical characters can be used for a folder name or a comment.

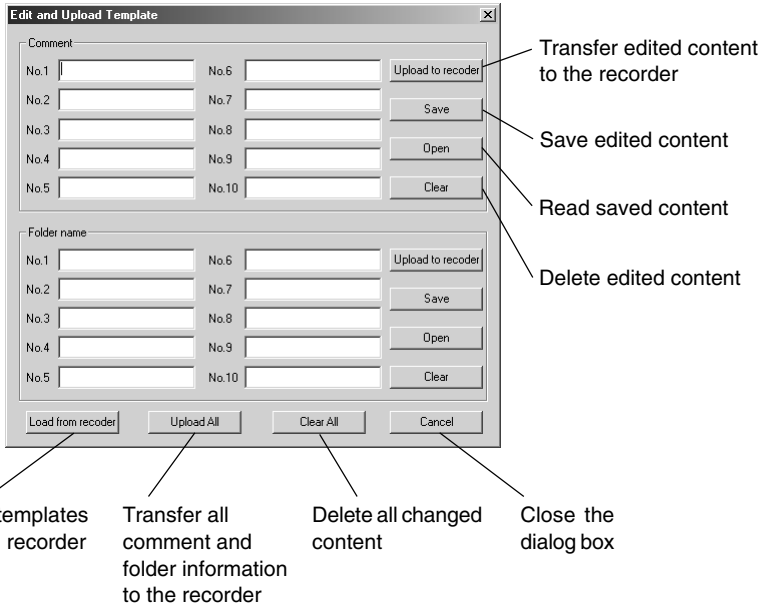



# Using Voice Recognition Software (optional)

When you use voice-recognition software such as IBM ViaVoice, it is recommended that you set the recorder to PC microphone and have the software learn the characteristics of the speaker's voice and the recorder's built-in microphone to maximize the accuracy of voice recognition.

**1** Click the [Start] button and select [Programs] → [IBM ViaVoice VoiceCenter].

**2** Click the [ViaVoice] button of [IBM ViaVoice VoiceCenter], then select [Tool] and [Analyze My Voice].

**3** The [ViaVoice User Wizard] window appears.

Select [Olympus DSS File] in the [Device] list box, then click the [Next] button.

**4** The [Audio Setup Wizard] window opens.

Use PC connection cable (KP4) if you use Windows 98, or use the USB connection cable if you use Windows 98SE or later operating system versions.

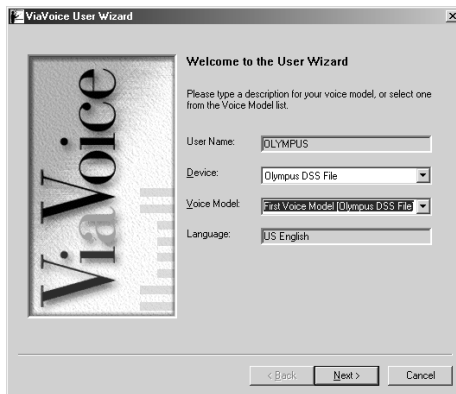

### Using the USB Cable

- 1 Connect the recorder with the USB cable, and follow the instructions on screen. Release the **HOLD** switch.
- 2 [Selecting a Sound Card]  
When the [Selecting a Sound Card] window appears, select [USB Audio Device] for [Input] and follow the instructions on screen. (Select [Microphone Control (DS-330)] for Windows XP.)

During audio setup or while enrolling, please input voice data from the recorder.

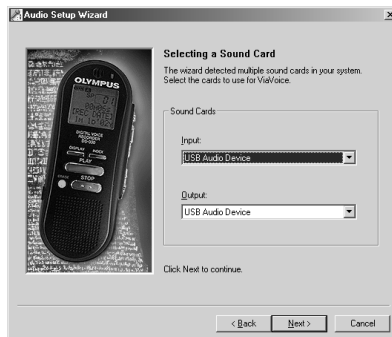

### Using the PC Connection Cable

- 1 Do not connect the recorder, and follow the instructions on screen.
- 2 [Connect Input Device]  
When the [Connect Input Device] window appears, connect the recorder and your PC using the PC connection cable by following the instructions on screen.

To input voice during audio setup or while enrolling, turn on the microphone by pressing the **NEW** button on the recorder. "TRAIN PC" appears on the recorder display.



We recommend you enroll the surrounding environment using the recorder before using voice recognition on files. This enables you to better register the characteristics of your voice to improve recognition.

### Notes

- Set the recording mode to "SP" when enrolling using the PC connection cable (KP4). If you set it to "LP" mode, a warning "CHANGE REC MODE" appears and you won't be able to enroll. (P.18)
- Turn "OFF" the USB AUDIO on the recorder's menu settings and use the PC connection cable (KP4) to enroll. (P.41)
- Voice recognition is only available with Windows operating systems.

## Executing Voice Recognition

### 1 Select the folder.

Select the folder containing the voice file you want to process with voice recognition from the Dictation Folder window.

### 2 Select the voice file.

Select the desired voice file to process with voice recognition from the Voice File List Box.

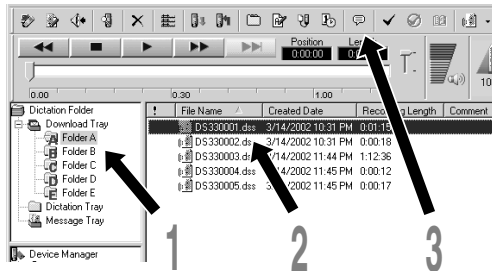

### 3 Start of voice recognition.

Click the start voice recognition icon .

The voice recognition software window appears and voice recognition starts.

### Noise Canceling Function

Check [Use Noise Cancel] in [Voice Recognition] on the menu bar, to output voice using the noise canceling function to the voice recognition software.

See the voice recognition software operating manual for voice recognition functions such as modifying converted characters.

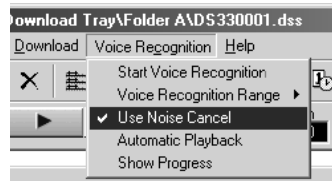

## Notes on Recording For Voice Recognition

When recording voices for use in voice recognition, set up your DSS recorder as follows to facilitate recognition.

- Set the microphone sensitivity to "DICT". (P.19)
- Set the recording mode to "SP". (P.18)
- Set the Variable Control Voice Actuator (VCVA) to "OFF". (P.16)
- Only record voices that have already been registered in the voice recognition software speak.
- Record in a relatively quiet environment.
- Have the person speaking within 5-10 cm of the built-in microphone of the recorder (5 to 10 cm).
- Speak continuously.

Voice files recorded under the following conditions cannot be processed by voice recognition because their recognition rates may be very low.

- A conference or meeting where the voices of many people have been recorded.
- Seminar or lecture in which ambient noise tends to be recorded.

# USB Microphone/USB Speaker (USB AUDIO)

## Using the recorder as a USB speaker

This recorder can be used as USB speaker when it's connected to a PC. If you use the recorder as a USB speaker, you can output voice from the recorder without using a PC speaker.

Select [Select Speaker] from [Tools] on the menu bar, and choose voice output.



## Using the recorder as USB microphone

This recorder can function as a USB microphone when it's connected to a PC. If you use voice recognition software or other applications, you can use the recorder as a USB microphone.

### For Windows 98SE, Me, 2000

Select [Control Panel] → [(Sound and) Multimedia] → [Audio] tab, and choose [USB Audio Device] from among the recording devices.

### For Windows XP

Select [Control panel] → [Sound, Voice, and Audio Device] → [Sound and Audio Device] → [Audio] tab, and chose [Microphone Control (DS-330)] from among the recording devices.

## Notes

- USB speaker can be switched using [Control Panel], in the same manner as the USB microphone.
- Do not use the recorder as a USB microphone/speaker on Windows 98 as computer operation may become unstable. (Use only with Windows 98SE or later versions of the OS.)
- The recorder can be used as a USB microphone/speaker only with Windows.
- If you turn the USB AUDIO "OFF" using the recorder's menu setting, you cannot use the recorder as a USB Microphone/USB Speaker. (☞ P.41)
- You cannot use the recorder as a USB Microphone/USB Speaker on Windows NT.

# Alarm Message List

Message	Meaning	Explanation	Action
BATTERY LOW	Low battery power	Battery power is getting low.	Replace with new batteries. (☞ P.8)
LOCK ON	Erase-locked	Tried to delete a locked file.	Unlock the file. (☞ P.26)
INDEX FULL	Index full	The file is full of index marks (maximum of 16 marks).	Erase index marks that are no longer required. (☞ P.27)
FOLDER FULL	Folder full	The folder is full of files (maximum of 199 files).	Erase unnecessary files. (☞ P.24)
	Maximum number	The destination folder already has the maximum number of files (199).	Erase unnecessary files. (☞ P.24)
MEMORY FULL	Zero remaining memory	No remaining internal memory.	Erase unnecessary files. (☞ P.24)
NO FILE	No file	No files were found in the folder.	Select another folder.
CHANGE REC MODE	Change recording mode	For voice recognition applications, the recording mode cannot be set to LP when using the connection cable KP4.	Set the recording mode to SP when using connection cable KP4. (☞ P.18)
MEMORY ERROR	Error in the internal flash memory	Error in the internal memory.	This is a malfunction, so go to the store where you purchased the recorder or an Olympus service station for repair.
SYSTEM ERROR	System error	System error detected in the recorder.	This is a malfunction, so go to the store where you purchased the recorder or an Olympus service station for repair.
OVER FLOW	Too many characters input	Exceeds the maximum number of characters that can be registered.	Reduce the number of characters within the limit. Up to eight characters can be used for a folder name. (☞ P.32-34) Up to 100 characters can be used for a file comment. (☞ P.35)
TRAIN PC	PC microphone indicator	The recorder is being used as a PC microphone. (☞ P.66)	See DSS Player online help for details.
FORMAT ERROR	Formatting error	There was an error while formatting the recorder's memory.	Reformat the memory. (☞ P.40)

# Troubleshooting

Symptom	Probable cause	Action
Nothing appears on the display	The batteries are not loaded properly.	Verify polarity is correct.
	The batteries are dead.	Replace with new batteries.
	If none of these suggestions works	Reset the recorder. (☞ P.40)
Won't start	The recorder is in HOLD mode.	Release the recorder from HOLD. (☞ P.9)
	The batteries are dead.	Replace with new batteries.
Unable to record	Low remaining internal flash memory.	Erase unnecessary files.
	The maximum number of files has been reached.	Check another folder.
No playback tone heard	The earphone is connected.	Unplug the earphones to use the internal speaker.
	The <b>VOLUME</b> control is set to 0.	Adjust the <b>VOLUME</b> control.
Unable to erase	The file is locked.	Unlock the file. (☞ P.26)
Noise heard during playback	The recorder was shaken during recording.	
	The recorder was placed near a cell phone or fluorescent lamp while recording or during playback.	Move the recorder.
Recording level too low	The microphone sensitivity is too low.	Set the microphone sensitivity to CONF mode and try again. (☞ P.19)
Unable to set index marks	The maximum number of index marks (16) has been reached.	Erase unnecessary index marks. (☞ P.27)
	The file is locked.	Unlock the file. (☞ P.26)
Won't work with AC adapter	A non-standard AC adapter is being used.	Use the Olympus A321 (for US, Canada) or A322 (for Europe except U.K) AC adapter (Optional).
Cannot find the recorded voice	Wrong folder.	Switch to the right folder.

<b>Symptom</b>	<b>Probable cause</b>	<b>Action</b>
<b>Cannot use Fast Playback or Slow Playback</b>	Noise Cancel function is set to "LOW" or "HI".	Turn "OFF" the Noise Cancel function. (☞ P.23)
<b>Noise Cancel function doesn't work</b>	A file is being played back in Fast Playback or Slow Playback mode.	The Noise Cancel function doesn't work while a file is being played back in Fast Playback or Slow Playback mode. (☞ P.21)
<b>Cannot connect to PC</b>	Some PCs and USB hubs may not provide sufficient power.	Turn the USB AUDIO "OFF" in the recorder's menu settings. (☞ P.41)
<b>Cannot connect to a PC using a cradle</b>	Sometimes a connection cannot be made with some PCs running Windows XP.	You need to change the PC's USB settings. See DSS Player online help for details. (☞ P.49)



# Accessories (optional)

---

## **External microphone: ME9\*/11\***

A lavalier omnidirectional microphone that clips to clothing. Use to record your own voice or people near you.

## **Conference microphone: ME7**

A highly sensitive directional microphone (shotgun microphone). Use to record speakers at a distance.

## **Headset: E102**

Stereo headset for your PC. A helpful tool for PC based transcription.

## **Foot switch: RS23/24**

Connect to the serial or USB port of your PC for hands-free transcription convenience.

## **Noise-Cancellation microphone: ME12 (Dictation microphone)**

Used to get crisp recordings of your own voice by reducing the effects of ambient noise.

Recommended to improve the accuracy when using voice-recognition software.

## **AC adapter: A321 (US and Canada) or A322 (Europe except U.K.)**

## **Connecting cord: KA232\***

Use to connect the microphone jack of this unit to a radio or other sound source.

## **Plug adapter: PA3**

An adapter that connects devices such as microphones with  $\varnothing 2.5$  mm mini-plugs to the unit's  $\varnothing 3.5$  mm mini-jack.

\* Use these accessories with the PA3 plug adapter.

# Specifications

---

<b>Recording format</b> .....	DSS (Digital Speech Standard)
<b>Input level</b> .....	-70 dBv
<b>Sampling frequency</b>	
SP mode: .....	12 kHz
LP mode: .....	8 kHz
<b>Overall frequency response</b>	
SP mode: .....	300 to 5,000 Hz
LP mode: .....	300 to 3,000 Hz
<b>Recording time</b>	
SP mode: .....	2 hours 35 minutes
LP mode: .....	5 hours 30 minutes
<b>Battery life</b>	
Recording: .....	Approx. 12 hours
Playback: .....	Approx. 8 hours (with alkaline batteries, based on our standard testing procedure)
<b>Speaker</b> .....	Built-in ø28 mm round dynamic speaker
<b>Microphone jack</b> .....	ø3.5 mm mini-jack, impedance 2 k $\Omega$
<b>Earphone jack</b> .....	ø3.5 mm mini-jack, impedance 8 $\Omega$ or more
<b>Maximum working output (3 V DC)</b> .....	250 mW or more (8 $\Omega$ speaker)
<b>Input power requirement</b>	
Rated voltage: .....	3 V
Batteries: .....	Two AAA batteries (LR03 or R03)
External power supply: .....	AC adapter
<b>External dimensions</b> .....	108 x 41.5 x 21mm (without protrusions)
<b>Weight</b> .....	75 g (including batteries)

\* Specifications and design are subject to change without notice.

\* Battery life varies greatly according to type of batteries used and the conditions of use.

# Technical Assistance and Support

---

The following are for only technical questions and support about OLYMPUS recorder and software.

- ◆ Technical Hotline Number in the U.S. and Canada  
1-888-553-4448
- ◆ User Support E-mail address in the U.S. and Canada  
distec@olympus.com
- ◆ Technical Hotline Number in Europe  
Toll free number  
00800 67 10 83 00  
available for Austria, Belgium, Denmark, France, Germany, Netherlands, Norway, Sweden,  
Switzerland, United Kingdom  
  
Charged numbers  
+49 180 567 1083  
available for Finland, Italy, Luxemburg, Portugal, Spain and Czech Republic  
+49 40 23773 899  
available for Greece, Croatia, Hungary and the rest of Europe
- ◆ User Support E-mail address in Europe  
dss.support@olympus-europa.com

## OLYMPUS OPTICAL CO., LTD.

San-Ei Building, 22-2, Nishi Shinjuku 1-chome, Shinjuku-ku, Tokyo, Japan. Tel. 03-3340-2211

## OLYMPUS AMERICA INC.

Two Corporate Center Drive, Melville, NY 11747-3157, U.S.A. Tel. 1-800-622-6372

## OLYMPUS OPTICAL CO (EUROPA) GMBH.

(Premises/Goods delivery) Wendenstrasse 14-18, 20097 Hamburg, Germany. Tel. 040-237730  
(Letters) Postfach 10 49 08. 20034 Hamburg. Germany.

## OLYMPUS OPTICAL CO. (U.K.) LTD.

2-8 Honduras Street, London EC1Y 0TX, United Kingdom, Tel. 020-7253-2772

<http://www.olympus.com>

### Declaration of Conformity

Model Number:	DS-330
Trade Name:	DIGITAL VOICE RECORDER
Responsible Party:	OLYMPUS AMERICA INC.
Address:	2 Corporate Center Drive, Melville, NY 11747-3157, U.S.A.
Telephone Number:	800-622-6372

This device Complies with Part 15 of the FCC Rules. Operation is subject to the following two conditions: (1) This device may not cause harmful interference, and (2) this device must accept any interference received, including interference that may cause undesired operation.



Tested To Comply  
With FCC Standards

FOR HOME OR OFFICE USE

### Canadian RFI

This digital apparatus does not exceed the Class B limits for radio noise emissions from digital apparatus as set out in the Radio Interference Regulations of the Canadian Department of Communications.

Cet appareil numérique ne dépasse pas limites de Catégorie B pour les émissions de bruit radio émanant d'appareils numériques, tel que prévu dans les Règlements sur l'Interférence Radio du Département Canadian des Communications.



"CE" mark indicates that this product complies with the European requirements for safety, health, environment and customer protection.



Das „CE“ Zeichen bestätigt die Übereinstimmung mit den Europäischen Bestimmungen für Betriebssicherheit und Umweltschutz.



La marca "CE" indica que este producto se encuentra de conformidad con las exigencias europeas sobre seguridad, salud, medio ambiente y protección al consumidor.



L'indication "CE" signifie que ce produit est conforme aux exigences concernant la sécurité, la santé, l'environnement et la protection du consommateur.



Il marchio "CE" indica che questo prodotto è conforme alle norme della comunità europea per quanto riguarda la sicurezza, la salute, l'ambiente e la protezione del consumatore.